

# Data sheet | Item number: 765-1502/100-000

16-channel digital input/output; EtherNet/IP; DC 24 V / 2.0 A; 8xM12 connection; WideLine

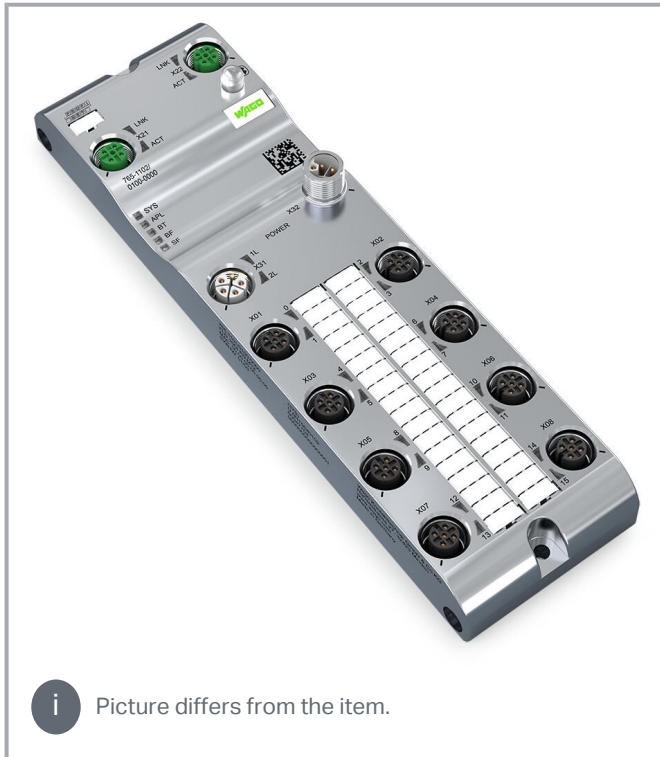

[www.wago.com/765-1502/100-000](http://www.wago.com/765-1502/100-000)



*i* Picture differs from the item.

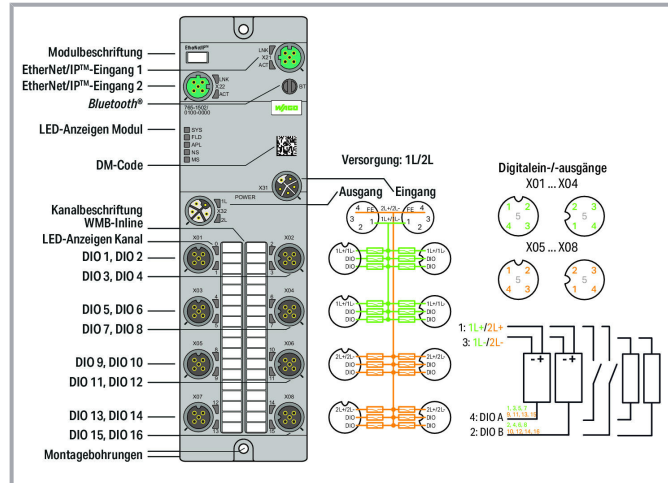

## Data Technical data

### Fieldbus

Communication

EtherNet/IP™  
BOOTP, DHCP, DLR

EtherNet/IP™  
BOOTP, DHCP, DLR

Connection technology: communication/fieldbus	2 x D-coded M12; 4-pole
Interface standard	10BASE-T/100BASE-TX; potential-free
Autonegotiation; autocrossover	yes

Subject to changes. Please also observe the further product documentation!

WAGO GmbH & Co. KG  
Hansastr. 27  
32423 Minden  
Phone: +49571 887-0 | Fax: +49571 887-169  
Email: [info.de@wago.com](mailto:info.de@wago.com) | Web: [www.wago.com](http://www.wago.com)

Do you have any questions about our products?  
We are always happy to take your call at +49 (571) 887-44222.



## Device Functions

Parameters	Input filter Output current Temperature
Diagnostics	Undervoltage; Overcurrent; Overload; Overtemperature
Device functions	Bluetooth® Bluetooth® OPC UA Server
Visualization	Android/iOS app Webserver

## Digital inputs/outputs

Number of digital inputs	16
Number of digital outputs	16
Connection technology: inputs/outputs	8 x A-coded M12; 5-pole
Voltage signal type	24 VDC
Input characteristic	High-side switching
Input filter	0.2 ... 20 ms
Input characteristic	Type 3, per IEC 61131-2
Output current (per channel)	2 A (typ.) for DO
Supply current per port	1L/2L: 4 A (max.)

## Module Power Supply

Connection technology: supply	2 x L-coded M12; 5-pole
Supply voltage	24 VDC (18 ... 31.2 V); 1L/2L
Power consumption (max.)	16000 mA
Power consumption (note)	per supply line; overload- and short-circuit-protected
Reverse voltage protection	Yes

## Geometrical Data

Width	60 mm / 2.362 inch
Height	30 mm / 1.181 inch
Depth	210 mm / 8.268 inch

## Mechanical Data

Weight	610 g
--------	-------

Subject to changes. Please also observe the further product documentation!

Conformity marking	CE
--------------------	----

## Environmental Requirements

Surrounding air temperature (operation)	-25 ... +70 °C
Surrounding air temperature (storage)	-40 ... +80 °C
Protection type	IP67
Protection class	III per EN 61140, IEC 61140, VDE 0140-1
Operating altitude	0 ... 2000 m
Pollution degree (5)	3 per EN 60664-1
Overvoltage category	II (EN 60664-1)
Relative humidity (without condensation)	95 %
Vibration resistance	5g per IEC 60068-2-6
Shock resistance	Short-term: 50g/11 ms/half-sine per IEC 60068-2-27; Long-term: 30g/6 ms/half-sine per IEC 60068-2-29
EMC immunity to interference	per EN 61000-6-2
EMC emission of interference	per EN 61000-6-4

## Commercial data

PU (SPU)	1 Pieces
Packaging type	BOX
Country of origin	DE
GTIN	4055144009941
Customs tariff number	85371098990

## Required accessories

### Marking accessories

#### Marking strip



**Item no.: 2009-110**

Marking strips; for Smart Printer; on reel; not stretchable; plain; snap-on type; white

[www.wago.com/2009-110](http://www.wago.com/2009-110)

#### Marker



**Item no.: 2009-115**

WMB-Inline; for Smart Printer; 1500 pieces on roll; stretchable 5 - 5.2 mm; plain; snap-on type; white

[www.wago.com/2009-115](http://www.wago.com/2009-115)

### Tool

#### Assembly tool

**Item no.: 206-701**

Torque wrench M8 and M12; Assembly kit

[www.wago.com/206-701](http://www.wago.com/206-701)

Subject to changes. Please also observe the further product documentation!

WAGO GmbH & Co. KG

Hansastr. 27

32423 Minden

Phone: +49571 887-0 | Fax: +49571 887-169

Email: [info.de@wago.com](mailto:info.de@wago.com) | Web: [www.wago.com](http://www.wago.com)

Do you have any questions about our products?

We are always happy to take your call at +49 (571) 887-44222.



## Cover



Cover		
	<b>Item no.: 756-8102</b> M12 protective cap; for unused sockets	<a href="http://www.wago.com/756-8102">www.wago.com/756-8102</a>
◆	<b>Item no.: 756-8103</b> M12 protective cap; for unused plugs	<a href="http://www.wago.com/756-8103">www.wago.com/756-8103</a>

## Optional accessories

## Cables and pluggable connectors

Sensor/actuator cable		
	<b>Item no.: 756-5402/040-010</b> Sensor/Actuator cable; M12A socket; straight; M12A plug; angled; 4-pole; Length: 1 m	<a href="http://www.wago.com/756-5402/040-010">www.wago.com/756-5402/040-010</a>
	<b>Item no.: 756-5402/040-020</b> Sensor/Actuator cable; M12A socket; straight; M12A plug; angled; 4-pole; Length: 2 m	<a href="http://www.wago.com/756-5402/040-020">www.wago.com/756-5402/040-020</a>
	<b>Item no.: 756-5311/040-050</b> Sensor/Actuator cable; M12A plug; straight; 4-pole; Length: 5 m	<a href="http://www.wago.com/756-5311/040-050">www.wago.com/756-5311/040-050</a>
	<b>Item no.: 756-5311/040-015</b> Sensor/Actuator cable; M12A plug; straight; 4-pole; Length: 1.5 m	<a href="http://www.wago.com/756-5311/040-015">www.wago.com/756-5311/040-015</a>
	<b>Item no.: 756-5311/040-100</b> Sensor/Actuator cable; M12A plug; straight; 4-pole; Length: 10 m	<a href="http://www.wago.com/756-5311/040-100">www.wago.com/756-5311/040-100</a>
	<b>Item no.: 756-5404/040-020</b> Sensor/Actuator cable; M12A socket; angled; M12A plug; angled; 4-pole; Length: 2 m	<a href="http://www.wago.com/756-5404/040-020">www.wago.com/756-5404/040-020</a>
	<b>Item no.: 756-5510/040-010</b> Sensor/Actuator cable; M8 socket; angled; M12A plug; angled; 4-pole; Length: 1 m	<a href="http://www.wago.com/756-5510/040-010">www.wago.com/756-5510/040-010</a>
	<b>Item no.: 756-5510/040-020</b> Sensor/Actuator cable; M8 socket; angled; M12A plug; angled; 4-pole; Length: 2 m	<a href="http://www.wago.com/756-5510/040-020">www.wago.com/756-5510/040-020</a>
	<b>Item no.: 756-5401/040-020</b> Sensor/Actuator cable; M12A socket; straight; M12A plug; straight; 4-pole; Length: 2 m	<a href="http://www.wago.com/756-5401/040-020">www.wago.com/756-5401/040-020</a>
	<b>Item no.: 756-5401/040-010</b> Sensor/Actuator cable; M12A socket; straight; M12A plug; straight; 4-pole; Length: 1 m	<a href="http://www.wago.com/756-5401/040-010">www.wago.com/756-5401/040-010</a>

Subject to changes. Please also observe the further product documentation!

<b>Item no.: 756-5507/040-010</b> Sensor/Actuator cable; M8 socket; straight; M12A plug; straight; 4-pole; Length: 1 m	<a href="http://www.wago.com/756-5507/040-010">www.wago.com/756-5507/040-010</a>
<b>Item no.: 756-5507/040-020</b> Sensor/Actuator cable; M8 socket; straight; M12A plug; straight; 4-pole; Length: 2 m	<a href="http://www.wago.com/756-5507/040-020">www.wago.com/756-5507/040-020</a>
<b>Item no.: 756-5404/040-010</b> Sensor/Actuator cable; M12A socket; angled; M12A plug; angled; 4-pole; Length: 1 m	<a href="http://www.wago.com/756-5404/040-010">www.wago.com/756-5404/040-010</a>
<b>Item no.: 756-5312/040-015</b> Sensor/Actuator cable; M12B socket; straight; 4-pole; Length: 1.5 m	<a href="http://www.wago.com/756-5312/040-015">www.wago.com/756-5312/040-015</a>
<b>Item no.: 756-5312/040-050</b> Sensor/Actuator cable; M12B socket; straight; 4-pole; Length: 5 m	<a href="http://www.wago.com/756-5312/040-050">www.wago.com/756-5312/040-050</a>
<b>Item no.: 756-5509/040-010</b> Sensor/Actuator cable; M8 socket; angled; M12A plug; straight; 4-pole; Length: 1 m	<a href="http://www.wago.com/756-5509/040-010">www.wago.com/756-5509/040-010</a>
<b>Item no.: 756-5509/040-020</b> Sensor/Actuator cable; M8 socket; angled; M12A plug; straight; 4-pole; Length: 2 m	<a href="http://www.wago.com/756-5509/040-020">www.wago.com/756-5509/040-020</a>
<b>Item no.: 756-5403/040-010</b> Sensor/Actuator cable; M12A socket; angled; M12A plug; straight; 4-pole; Length: 1 m	<a href="http://www.wago.com/756-5403/040-010">www.wago.com/756-5403/040-010</a>
<b>Item no.: 756-5312/040-100</b> Sensor/Actuator cable; M12B socket; straight; 4-pole; Length: 10 m	<a href="http://www.wago.com/756-5312/040-100">www.wago.com/756-5312/040-100</a>
<b>Item no.: 756-5403/040-020</b> Sensor/Actuator cable; M12A socket; angled; M12A plug; straight; 4-pole; Length: 2 m	<a href="http://www.wago.com/756-5403/040-020">www.wago.com/756-5403/040-020</a>
 <b>Item no.: 756-5508/040-010</b> Sensor/Actuator cable; M8 socket; straight; M12A plug; angled; 4-pole; Length: 1 m	<a href="http://www.wago.com/756-5508/040-010">www.wago.com/756-5508/040-010</a>
 <b>Item no.: 756-5508/040-020</b> Sensor/Actuator cable; M8 socket; straight; M12A plug; angled; 4-pole; Length: 2 m	<a href="http://www.wago.com/756-5508/040-020">www.wago.com/756-5508/040-020</a>
<b>Configurable connectors</b>	
<b>Item no.: 756-9202/040-000</b> Fitted pluggable connector; 4-pole; M12 plug, straight, A-coded; Spring	<a href="http://www.wago.com/756-9202/040-000">www.wago.com/756-9202/040-000</a>

Subject to changes. Please also observe the further product documentation!

Item no.: 756-9205/040-000

Fitted pluggable connector; 4-pole; M12 plug, right angle; Spring

[www.wago.com/756-9205/040-000](http://www.wago.com/756-9205/040-000)



Item no.: 756-9711/050-000

Fitted pluggable connector; 5-pole, shielded; M12 socket, straight; IDC technology

[www.wago.com/756-9711/050-000](http://www.wago.com/756-9711/050-000)



Item no.: 756-9701/050-000

Fitted pluggable connector; 5-pole, shielded; M12 plug, straight; IDC technology

[www.wago.com/756-9701/050-000](http://www.wago.com/756-9701/050-000)

Configurable shielded connectors

Item no.: 756-9501/060-000

Fitted pluggable connector; 5-pole, shielded; M12 plug, straight, D-coded; Spring

[www.wago.com/756-9501/060-000](http://www.wago.com/756-9501/060-000)

Item no.: 756-9501/040-000

Accessories; M12 plug, right angle; 4-pole

[www.wago.com/756-9501/040-000](http://www.wago.com/756-9501/040-000)

Power cable



Item no.: 756-3501/050-075

Power cable; M12L socket; straight; 5-pole; Length: 7.5 m

[www.wago.com/756-3501/050-075](http://www.wago.com/756-3501/050-075)



Item no.: 756-3501/050-100

Power cable; M12L socket; straight; 5-pole; Length: 10 m

[www.wago.com/756-3501/050-100](http://www.wago.com/756-3501/050-100)



Item no.: 756-3501/050-150

Power cable; M12L socket; straight; 5-pole; Length: 15 m

[www.wago.com/756-3501/050-150](http://www.wago.com/756-3501/050-150)



Item no.: 756-3501/050-050

Power cable; M12L socket; straight; 5-pole; Length: 5 m

[www.wago.com/756-3501/050-050](http://www.wago.com/756-3501/050-050)



Item no.: 756-3502/050-050

Power cable; M12L socket; angled; 5-pole; Length: 5 m

[www.wago.com/756-3502/050-050](http://www.wago.com/756-3502/050-050)



Item no.: 756-3502/050-150

Power cable; M12L socket; angled; 5-pole; Length: 15 m

[www.wago.com/756-3502/050-150](http://www.wago.com/756-3502/050-150)

Subject to changes. Please also observe the further product documentation!

WAGO GmbH & Co. KG

Hansastr. 27













32423 Minden

Phone: +49571 887-0 | Fax: +49571 887-169













Email: [info.de@wago.com](mailto:info.de@wago.com) | Web: [www.wago.com](http://www.wago.com)

Do you have any questions about our products?

We are always happy to take your call at +49 (571) 887-44222.

	<b>Item no.: 756-3502/050-075</b> Power cable; M12L socket; angled; 5-pole; Length: 7.5 m	<a href="http://www.wago.com/756-3502/050-075">www.wago.com/756-3502/050-075</a>
	<b>Item no.: 756-3502/050-100</b> Power cable; M12L socket; angled; 5-pole; Length: 10 m	<a href="http://www.wago.com/756-3502/050-100">www.wago.com/756-3502/050-100</a>
	<b>Item no.: 756-3503/050-075</b> Power cable; M12L plug; straight; 5-pole; Length: 7.5 m	<a href="http://www.wago.com/756-3503/050-075">www.wago.com/756-3503/050-075</a>
	<b>Item no.: 756-3503/050-150</b> Power cable; M12L plug; straight; 5-pole; Length: 15 m	<a href="http://www.wago.com/756-3503/050-150">www.wago.com/756-3503/050-150</a>
	<b>Item no.: 756-3503/050-100</b> Power cable; M12L plug; straight; 5-pole; Length: 10 m	<a href="http://www.wago.com/756-3503/050-100">www.wago.com/756-3503/050-100</a>
	<b>Item no.: 756-3505/050-003</b> Power cable; M12L socket; straight; M12L plug; straight; 5-pole; Length: 0.3 m	<a href="http://www.wago.com/756-3505/050-003">www.wago.com/756-3505/050-003</a>
	<b>Item no.: 756-3505/050-005</b> Power cable; M12L socket; straight; M12L plug; straight; 5-pole; Length: 0.5 m	<a href="http://www.wago.com/756-3505/050-005">www.wago.com/756-3505/050-005</a>
	<b>Item no.: 756-3505/050-020</b> Power cable; M12L socket; straight; M12L plug; straight; 5-pole; Length: 2 m	<a href="http://www.wago.com/756-3505/050-020">www.wago.com/756-3505/050-020</a>
	<b>Item no.: 756-3505/050-010</b> Power cable; M12L socket; straight; M12L plug; straight; 5-pole; Length: 1 m	<a href="http://www.wago.com/756-3505/050-010">www.wago.com/756-3505/050-010</a>
	<b>Item no.: 756-3505/050-050</b> Power cable; M12L socket; straight; M12L plug; straight; 5-pole; Length: 5 m	<a href="http://www.wago.com/756-3505/050-050">www.wago.com/756-3505/050-050</a>
	<b>Item no.: 756-3505/050-075</b> Power cable; M12L socket; straight; M12L plug; straight; 5-pole; Length: 7.5 m	<a href="http://www.wago.com/756-3505/050-075">www.wago.com/756-3505/050-075</a>
	<b>Item no.: 756-3505/050-100</b> Power cable; M12L socket; straight; M12L plug; straight; 5-pole; Length: 10 m	<a href="http://www.wago.com/756-3505/050-100">www.wago.com/756-3505/050-100</a>

Subject to changes. Please also observe the further product documentation!

	<b>Item no.: 756-3506/050-100</b> Power cable; M12L socket; angled; M12L plug; angled; 5-pole; Length: 10 m	<a href="http://www.wago.com/756-3506/050-100">www.wago.com/756-3506/050-100</a>
	<b>Item no.: 756-3506/050-075</b> Power cable; M12L socket; angled; M12L plug; angled; 5-pole; Length: 7.5 m	<a href="http://www.wago.com/756-3506/050-075">www.wago.com/756-3506/050-075</a>
	<b>Item no.: 756-3506/050-150</b> Power cable; M12L socket; angled; M12L plug; angled; 5-pole; Length: 15 m	<a href="http://www.wago.com/756-3506/050-150">www.wago.com/756-3506/050-150</a>
	<b>Item no.: 756-3501/050-020</b> Power cable; M12L socket; straight; 5-pole; Length: 2 m	<a href="http://www.wago.com/756-3501/050-020">www.wago.com/756-3501/050-020</a>
	<b>Item no.: 756-3502/050-020</b> Power cable; M12L socket; angled; 5-pole; Length: 2 m	<a href="http://www.wago.com/756-3502/050-020">www.wago.com/756-3502/050-020</a>
	<b>Item no.: 756-3503/050-020</b> Power cable; M12L plug; straight; 5-pole; Length: 2 m	<a href="http://www.wago.com/756-3503/050-020">www.wago.com/756-3503/050-020</a>
	<b>Item no.: 756-3503/050-050</b> Power cable; M12L plug; straight; 5-pole; Length: 5 m	<a href="http://www.wago.com/756-3503/050-050">www.wago.com/756-3503/050-050</a>
	<b>Item no.: 756-3504/050-020</b> Power cable; M12L plug; angled; 5-pole; Length: 2 m	<a href="http://www.wago.com/756-3504/050-020">www.wago.com/756-3504/050-020</a>
	<b>Item no.: 756-3504/050-050</b> Power cable; M12L plug; angled; 5-pole; Length: 5 m	<a href="http://www.wago.com/756-3504/050-050">www.wago.com/756-3504/050-050</a>
	<b>Item no.: 756-3504/050-075</b> Power cable; M12L plug; angled; 5-pole; Length: 7.5 m	<a href="http://www.wago.com/756-3504/050-075">www.wago.com/756-3504/050-075</a>
	<b>Item no.: 756-3504/050-100</b> Power cable; M12L plug; angled; 5-pole; Length: 10 m	<a href="http://www.wago.com/756-3504/050-100">www.wago.com/756-3504/050-100</a>
	<b>Item no.: 756-3504/050-150</b> Power cable; M12L plug; angled; 5-pole; Length: 15 m	<a href="http://www.wago.com/756-3504/050-150">www.wago.com/756-3504/050-150</a>

Subject to changes. Please also observe the further product documentation!





**Item no.:** 756-3505/050-150

Power cable; M12L socket; straight; M12L plug; straight; 5-pole; Length: 15 m

[www.wago.com/756-3505/050-150](http://www.wago.com/756-3505/050-150)



**Item no.:** 756-3506/050-003

Power cable; M12L socket; angled; M12L plug; angled; 5-pole; Length: 0.3 m

[www.wago.com/756-3506/050-003](http://www.wago.com/756-3506/050-003)



**Item no.:** 756-3506/050-005

Power cable; M12L socket; angled; M12L plug; angled; 5-pole; Length: 0.5 m

[www.wago.com/756-3506/050-005](http://www.wago.com/756-3506/050-005)



**Item no.:** 756-3506/050-020

Power cable; M12L socket; angled; M12L plug; angled; 5-pole; Length: 2 m

[www.wago.com/756-3506/050-020](http://www.wago.com/756-3506/050-020)



**Item no.:** 756-3506/050-010

Power cable; M12L socket; angled; M12L plug; angled; 5-pole; Length: 1 m

[www.wago.com/756-3506/050-010](http://www.wago.com/756-3506/050-010)



**Item no.:** 756-3506/050-050

Power cable; M12L socket; angled; M12L plug; angled; 5-pole; Length: 5 m

[www.wago.com/756-3506/050-050](http://www.wago.com/756-3506/050-050)

Distribution connector

**Item no.:** 756-5513/040-010

Sensor/Actuator cable; 2xM8 socket; straight; M12A plug; straight; 4-pole; Length: 1 m

[www.wago.com/756-5513/040-010](http://www.wago.com/756-5513/040-010)

**Item no.:** 756-5513/040-020

Sensor/Actuator cable; 2xM8 socket; straight; M12A plug; straight; 4-pole; Length: 2 m

[www.wago.com/756-5513/040-020](http://www.wago.com/756-5513/040-020)

**Item no.:** 756-5514/040-010

Sensor/Actuator cable; 2xM8 socket; angled; M12A plug; straight; 4-pole; Length: 1 m

[www.wago.com/756-5514/040-010](http://www.wago.com/756-5514/040-010)

**Item no.:** 756-5514/040-020

Sensor/Actuator cable; 2xM8 socket; angled; M12A plug; straight; 4-pole; Length: 2 m

[www.wago.com/756-5514/040-020](http://www.wago.com/756-5514/040-020)

**Item no.:** 756-5516/040-010

Sensor/Actuator cable; 2xM12 socket; straight; M12A plug; straight; 4-pole; Length: 1 m

[www.wago.com/756-5516/040-010](http://www.wago.com/756-5516/040-010)

**Item no.:** 756-5516/040-020

Sensor/Actuator cable; 2xM12 socket; straight; M12A plug; straight; 4-pole; Length: 2 m

[www.wago.com/756-5516/040-020](http://www.wago.com/756-5516/040-020)

**Item no.:** 756-5517/040-010

Sensor/Actuator cable; 2xM12 socket; angled; M12A plug; straight; 4-pole; Length: 1 m

[www.wago.com/756-5517/040-010](http://www.wago.com/756-5517/040-010)

Subject to changes. Please also observe the further product documentation!

WAGO GmbH & Co. KG

Hansastr. 27

32423 Minden

Phone: +49571 887-0 | Fax: +49571 887-169

Email: [info.de@wago.com](mailto:info.de@wago.com) | Web: [www.wago.com](http://www.wago.com)

Do you have any questions about our products?

We are always happy to take your call at +49 (571) 887-44222.

Item no.: 756-5517/040-020

Sensor/Actuator cable; 2xM12 socket; angled; M12A plug; straight; 4-pole; Length: 2 m

[www.wago.com/756-5517/040-020](http://www.wago.com/756-5517/040-020)



Item no.: 756-9301/050-000

Accessories; 5-pole

[www.wago.com/756-9301/050-000](http://www.wago.com/756-9301/050-000)

Item no.: 756-9301/040-000

Accessories; 4-pole

[www.wago.com/756-9301/040-000](http://www.wago.com/756-9301/040-000)

Adapter



Item no.: 756-9503/040-000

Accessories; 4-pole

[www.wago.com/756-9503/040-000](http://www.wago.com/756-9503/040-000)

Item no.: 756-9504/040-000

Accessories; 4-pole

[www.wago.com/756-9504/040-000](http://www.wago.com/756-9504/040-000)

ETHERNET/PROFINET cable



Item no.: 756-1202/060-200

ETHERNET cable; M12D plug; angled; 4-pole; Length: 20 m

[www.wago.com/756-1202/060-200](http://www.wago.com/756-1202/060-200)



Item no.: 756-1201/060-100

ETHERNET cable; M12D plug; straight; 4-pole; Length: 10 m

[www.wago.com/756-1201/060-100](http://www.wago.com/756-1201/060-100)



Item no.: 756-1201/060-050

ETHERNET cable; M12D plug; straight; 4-pole; Length: 5 m

[www.wago.com/756-1201/060-050](http://www.wago.com/756-1201/060-050)



Item no.: 756-1203/060-050

ETHERNET cable; M12D plug; straight; M12D plug; straight; 4-pole; Length: 5 m

[www.wago.com/756-1203/060-050](http://www.wago.com/756-1203/060-050)



Item no.: 756-1203/060-020

ETHERNET cable; M12D plug; straight; M12D plug; straight; 4-pole; Length: 2 m

[www.wago.com/756-1203/060-020](http://www.wago.com/756-1203/060-020)



Item no.: 756-1202/060-020

ETHERNET cable; M12D plug; angled; 4-pole; Length: 2 m

[www.wago.com/756-1202/060-020](http://www.wago.com/756-1202/060-020)

Subject to changes. Please also observe the further product documentation!

WAGO GmbH & Co. KG

Hansastr. 27

32423 Minden

Phone: +49571 887-0 | Fax: +49571 887-169

Email: [info.de@wago.com](mailto:info.de@wago.com) | Web: [www.wago.com](http://www.wago.com)

Do you have any questions about our products?

We are always happy to take your call at +49 (571) 887-44222.



**Item no.: 756-1201/060-200**  
ETHERNET cable; M12D plug; straight; 4-pole; Length: 20 m

[www.wago.com/756-1201/060-200](http://www.wago.com/756-1201/060-200)



**Item no.: 756-1204/060-050**  
ETHERNET cable; M12D plug; angled; M12D plug; angled; 4-pole; Length: 5 m

[www.wago.com/756-1204/060-050](http://www.wago.com/756-1204/060-050)



**Item no.: 756-1204/060-100**  
ETHERNET cable; M12D plug; angled; M12D plug; angled; 4-pole; Length: 10 m

[www.wago.com/756-1204/060-100](http://www.wago.com/756-1204/060-100)



**Item no.: 756-1204/060-200**  
ETHERNET cable; M12D plug; angled; M12D plug; angled; 4-pole; Length: 20 m

[www.wago.com/756-1204/060-200](http://www.wago.com/756-1204/060-200)



**Item no.: 756-1203/060-200**  
ETHERNET cable; M12D plug; straight; M12D plug; straight; 4-pole; Length: 20 m

[www.wago.com/756-1203/060-200](http://www.wago.com/756-1203/060-200)



**Item no.: 756-1203/060-100**  
ETHERNET cable; M12D plug; straight; M12D plug; straight; 4-pole; Length: 10 m

[www.wago.com/756-1203/060-100](http://www.wago.com/756-1203/060-100)



**Item no.: 756-1204/060-010**  
ETHERNET cable; M12D plug; angled; M12D plug; angled; 4-pole; Length: 0.1 m

[www.wago.com/756-1204/060-010](http://www.wago.com/756-1204/060-010)



**Item no.: 756-1204/060-030**  
ETHERNET cable; M12D plug; angled; M12D plug; angled; 4-pole; Length: 3 m

[www.wago.com/756-1204/060-030](http://www.wago.com/756-1204/060-030)



**Item no.: 756-1204/060-020**  
ETHERNET cable; M12D plug; angled; M12D plug; angled; 4-pole; Length: 2 m

[www.wago.com/756-1204/060-020](http://www.wago.com/756-1204/060-020)



**Item no.: 756-1202/060-050**  
ETHERNET cable; M12D plug; angled; 4-pole; Length: 5 m

[www.wago.com/756-1202/060-050](http://www.wago.com/756-1202/060-050)



**Item no.: 756-1202/060-100**  
ETHERNET cable; M12D plug; angled; 4-pole; Length: 10 m

[www.wago.com/756-1202/060-100](http://www.wago.com/756-1202/060-100)



**Item no.: 756-1201/060-020**  
ETHERNET cable; M12D plug; straight; 4-pole; Length: 2 m

[www.wago.com/756-1201/060-020](http://www.wago.com/756-1201/060-020)

Subject to changes. Please also observe the further product documentation!



## Downloads

### Documentation

#### Manual

16-Channel Digital Input/Output; EtherNet/IP DC 24 V / 2.0 A; 8xM12 Connection; WideLine	V 1.1.0 2021年4月20日	pdf 5.8 MB	Download
---	-----------------------	---------------	----------

#### System Description

WAGO I/O System Field; General Product Information		pdf 708.2 kB	Download
--	--	-----------------	----------

## Runtime Software

### Firmware

Ethernet/IP IO-Field 765-x5xx Firmware Download WAGO_FW0765-x5xx_V01010011_IX01.zip	V 01 2021年7月23日	zip 41.3 MB	Download
--	--------------------	----------------	----------

## CAD/CAE-Data

### CAD data

2D/3D Models 765-1502/100-000		URL	Download
-------------------------------	--	-----	----------

## Device Files

### Device Description File

750-915; EDS-Dateien for EthernetIP / Serie 750, 765 and 767	12 2021年7月9日	zip 168.4 kB	Download
--	-----------------	-----------------	----------

Gerätebeschreibungsdateien 765-45xx, 765-15xx, EtherNet/IP	V1_1_0_11	zip 74 B	Download
--	-----------	-------------	----------

## Environmental Product Compliance

### Compliance Search

Environmental Product Compliance 765-1502/100-000 16-channel digital input/output; EtherNet/IP; DC 24 V / 2.0 A; 8xM12 connection; WideLine		URL	Download
---	--	-----	----------

Subject to changes. Please also observe the further product documentation!



## Installation Notes

## Product family

**WAGO I/O System Field**

Show all products from the family

Subject to changes. Please also observe the further product documentation!

---

WAGO GmbH & Co. KG

Hansastr. 27

32423 Minden

Phone: +49571 887-0 | Fax: +49571 887-169

Email: [info.de@wago.com](mailto:info.de@wago.com) | Web: [www.wago.com](http://www.wago.com)

Do you have any questions about our products?

We are always happy to take your call at +49 (571) 887-44222.